

JUNIOR TIMER VALVE PLUG LED VDR

PUR 2x0,5 black drag ch AIN 5m

Female straight
10...24 V AC/30 V DC
LED and VDR

Plastic housings with good resistance against chemicals and oils.

The resistance to aggressive media should be individually tested for your application. Further details on request.

Further cable lengths on request.

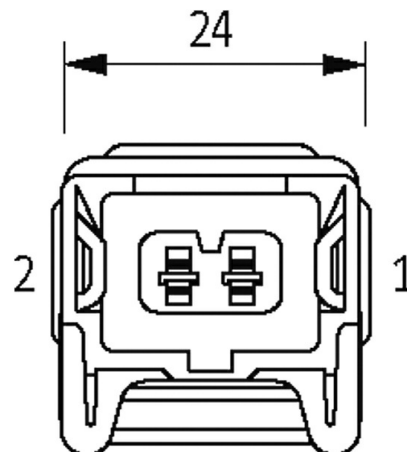
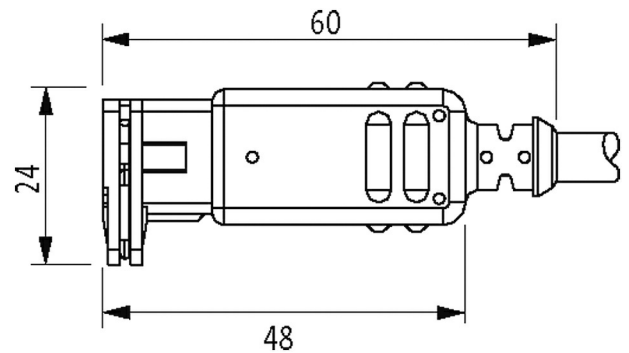
[Link to Product](#)**Illustration**

Product may differ from Image

Form

The information in this brochure has been compiled with the utmost care.

Liability for the correctness completeness and topicality of the information is restricted to gross negligence. Version: 11/20

Form	70061
General data	
Temperature range	-25...+85 °C, depending on cable quality
Cables	
No./diameter of wires	2× 0.5 mm ²
Wire isolation	TPE (bk, wh)
C-track properties	2 Mio.
Jacket Color	black
Material (jacket)	PUR
Outer Ø	5.0 mm ±5%
Bend radius (moving)	10× outer Ø
Temperature range (fixed)	-50...+90 °C
Temperature range (mobile)	-30...+90 °C
Cable identification	740
Approval (cable)	CE conform
Cable weight [g/m]	36,30
Material (wire)	Cu wire, bare
Resistor (core)	max. 39 Ω/km (20 °C)
Single wire Ø (core)	0.1 mm
Construction (core)	64× 0.1 mm (multi-strand wire class 6)
Diameter (core)	2× 0.5 mm ²
AWG	similar to AWG 20
Material (wire isolation)	TPE-E
Wire-Ø incl. isolation	1.5 mm ±5%
Color/numbering of wires	bk, wh
Stranding combination	2 wires twisted
Shield	no
Material (jacket)	PUR
Outer-Ø (jacket)	5.0 mm ±5%
Color (jacket)	black
Nominal voltage	300/500 V AC
Test voltage	2000 V AC
Temperature range (fixed)	-50...+90 °C
Temperature range (mobile)	-30...+90 °C
Bend radius (moving)	10× outer Ø
No. of bending cycles (C-track)	max. 2 Mio. (25 °C)
Traversing distance (C-track)	max. 5 m (horizontal)
Travel speed (C-track)	max. 3.3 m/s
Acceleration (C-track)	max. 5 m/s ²
Technical Data	
Operating voltage	10...24 V AC/30 V DC
Operating current per contact	max. 4 A
Current consumption	approx. 12 mA
LED display	(yellow)
Protection	IP65 inserted and tightened (EN 60529)
Housing	Black plastic, flame retardant
Rated surge voltage	0.8 kV
Commercial data	

country of origin	DE
customs tariff number	85444290
EAN	4048879135450
eClass	27279218
Packaging unit	1
